



BOM



Flat Pack Packaging



Allen Key 3mm X1



Flat Base (if applicable)



Flat Head Allen Bolt (if applicable)



Washer (if applicable)



(Optional) Mounting Bracket x 4



Flat Fitting (if applicable)



Wing Nut (if applicable)



Allen Key 5mm X1 (if applicable)

STEP 1

Place the frame lengths flat on a clean surface, matching the corners as per **Image A**.

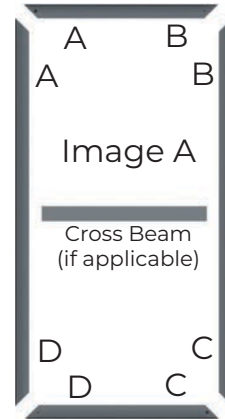

STEP 2

Insert the Male Locking System into the Female Locking System. Secure each corner in place by tightening the set screws with the provided Allen key.



STEP 3 (if applicable)

Place the flat fitting in the center of the profile channel between the two profile lengths. Join the profile lengths together and secure them by tightening the set screws.

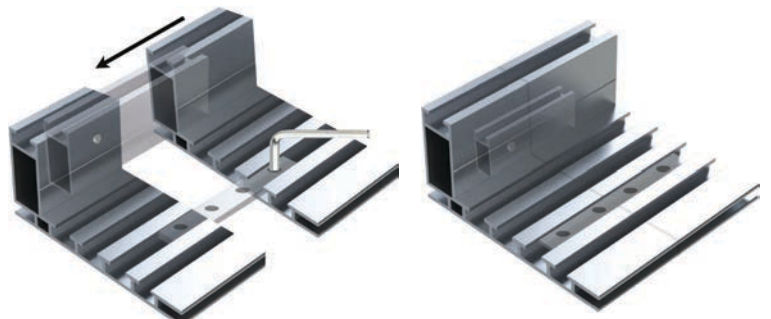



STEP 4 (if applicable)

Insert the Cross Beam lock system into the channel of the frame and center the cross beam to the arrow marked on the sticker attached to the profile.

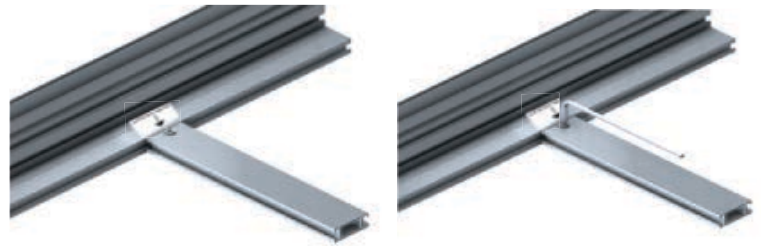

STEP 5 (If applicable)

Measure the dimensions of the inner frame then drill the four corner brackets into the wall at the desired location for the frame.

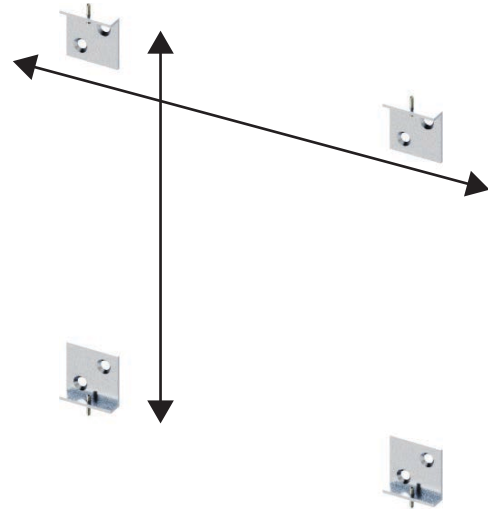

STEP 6 (If applicable)

Position the frame onto the top brackets and adjust the wall mount set screws to level it. Once the frame is aligned, secure it by tightening the bottom brackets.



STEP 7 (if applicable)

Insert the Flat Head Allen Bolt through the Flat Base and frame. Place a washer on the Allen Bolt, then secure by tightening the Wing Nut.

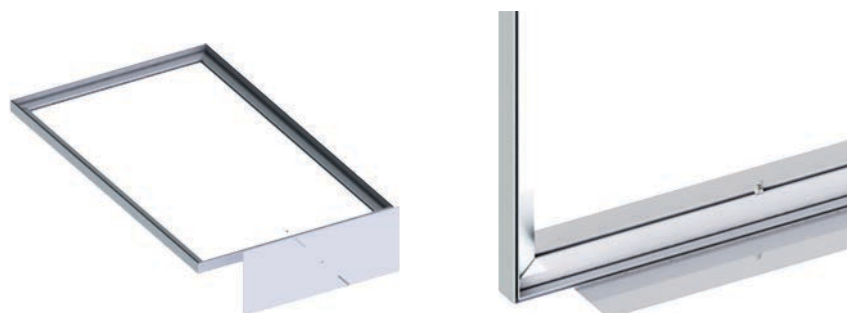

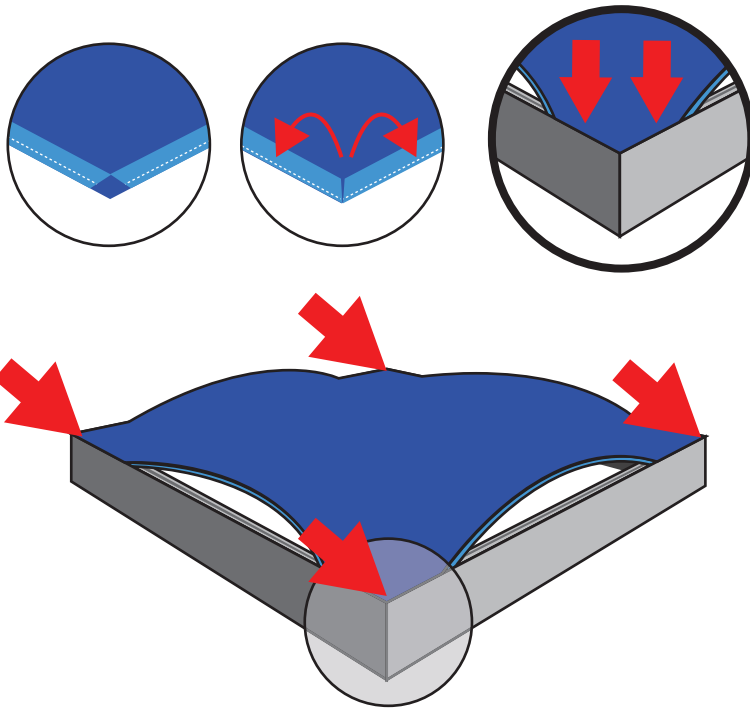

STEP 1

Begin by folding **Corner A** of the graphic, ensuring the silicone strip faces downward with the fabric wrapped over it. Carefully insert the silicone edge into the corresponding corner of the frame. Repeat for **Corner C**, then move to **Corner B**, followed by **Corner D** to complete the installation of all corners.

STEP 2
Insert the silicone strip at the mid-point of all four sides. Then, work outward from each mid-point toward the corresponding corners to complete the installation.

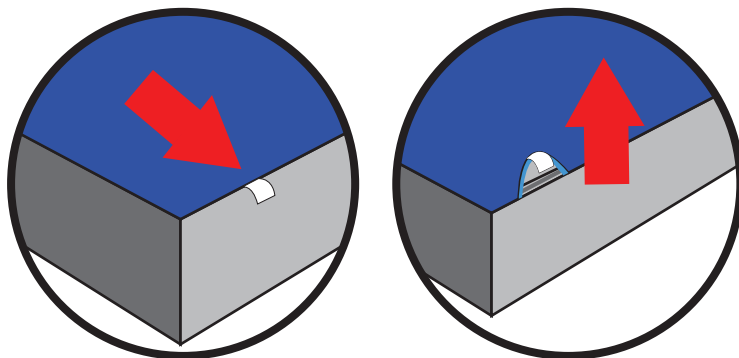
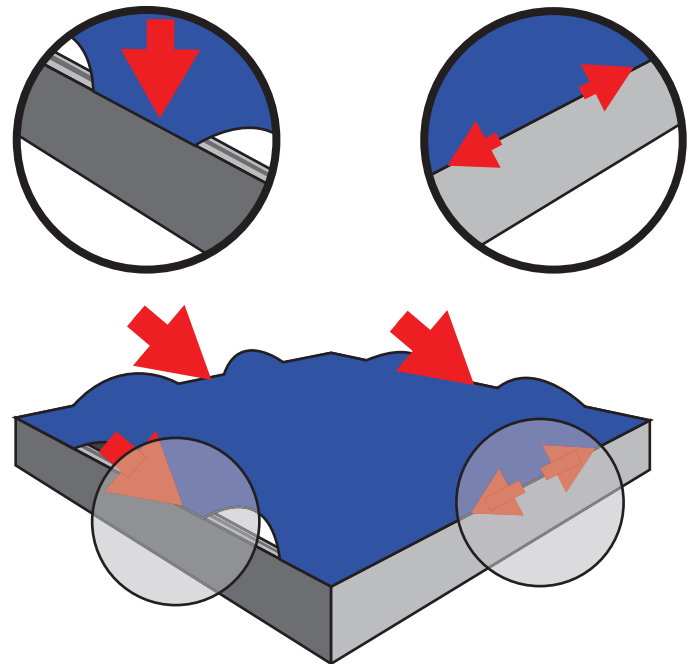

GRAPHIC REMOVAL

Locate the pull tab and gently pull up on the tab.